



Hilfield Solar Farm and Battery Storage

Design & Access Statement

on behalf of Elstree Green Limited

Prepared by [Aardvark EM Limited](#) | December 2020 | Document Reference: R004



DESIGN & ACCESS STATEMENT



Accompanying a planning application for the construction and operation of a grid-connected solar photovoltaic farm with battery storage, other ancillary infrastructure, access, landscaping and biodiversity enhancements on Land to the North East and West of Elstree Aerodrome, Hertfordshire

DECEMBER 2020

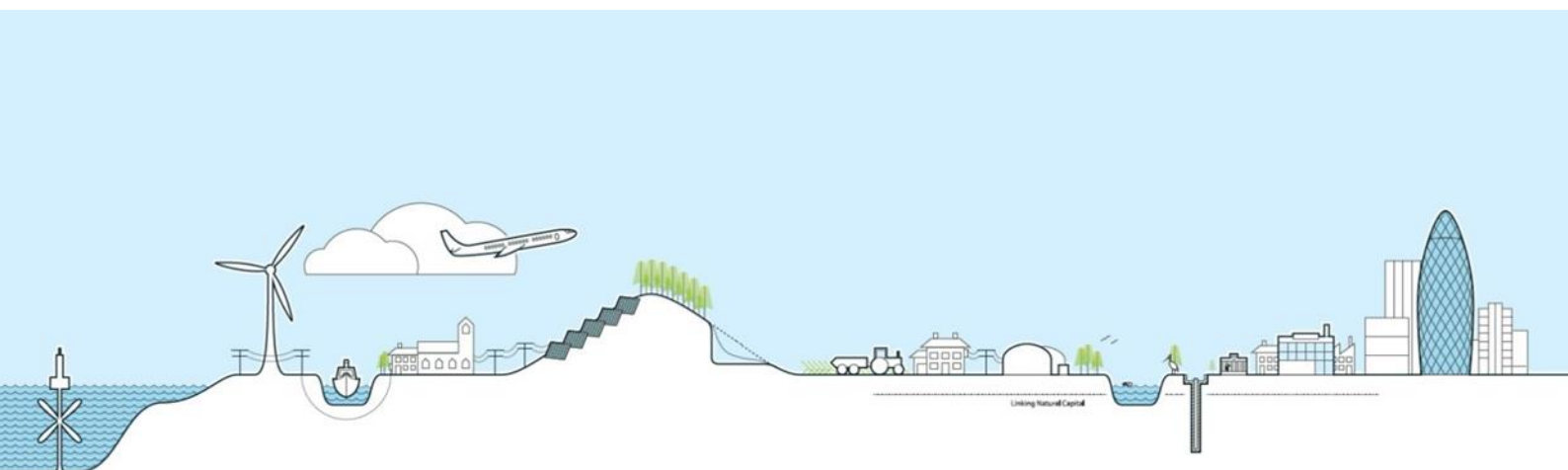
Prepared By



Project Quality Control Sheet

ORIGINAL	Author	Checked by	Approved by
Signature			
Date	15/12/2020	15/12/2020	15/12/2020
Company	Aardvark EM Ltd	Aardvark EM Ltd	Aardvark EM Ltd

Location: Land to the North East and West of Elstree Aerodrome, Hertfordshire

Grid Reference: TQ 515093 196697 (centre of application site)

Project Manager: Nicholas Leaney

Report Authors: Nicholas Leaney
Rachel Ness

Report Number: R004

Report Status: FINAL

Copyright: All copyright in this document is reserved.

Liability: This document contains information and may contain conclusions and recommendations. Every effort has been made to ensure that the information is accurate and that the opinions expressed are sound. However, Aardvark EM Limited cannot be made liable for any errors or omissions or for any losses or consequential losses resulting from decisions based on the information.

Report Written and Produced By

Aardvark EM Limited, Higher Ford, Wiveliscombe, Taunton, Somerset, TA4 2RL

Telephone: 01984 624989, Facsimile: 01984 623912

Email: environment@aardvarkem.co.uk, Web: www.aardvarkem.co.uk

Contents

1	Introduction	1
2	Site Location	3
3	The Site	5
3.1	Description.....	5
4	The Proposed Development	7
4.1	Nature of Solar Farms.....	8
4.2	Components of a Solar Farm	9
4.2.1	Solar Arrays.....	9
4.2.2	Inverters and Transformers.....	11
4.2.3	Battery Storage Units	11
4.2.4	Substation	12
4.2.5	Cabling	12
4.2.6	Site Security Measures	12
4.2.7	Lighting.....	13
4.3	Materials & Appearance	13
5	Construction	13
5.1	Construction	13
5.2	Maintenance	15
5.3	Operational Lifespan and Decommissioning	15
5.4	Climate Change.....	16
6	Site Selection	16
6.1	Environmental Context.....	16
6.1	Economic Context	18
6.2	Social Context	19
6.3	Planning Policy	19
6.4	Evaluation.....	20
7	Use	21
8	Layout	22
9	Amount & Scale	29
10	Appearance	30
11	Landscaping and Biodiversity	32
12	Access	33
12.1	Construction Access and routing	34
12.2	General Site and Maintenance Access.....	34

1 Introduction

This Design and Access Statement (DAS) has been prepared by Aardvark EM Limited on behalf of Elstree Green Limited (“the Applicant”) to accompany a full planning application to Hertsmere Borough Council (HBC) for the construction, operation and decommissioning of a grid connected solar farm with battery storage and associated infrastructure (“the Proposed Development”) on Land to the northeast and west of Elstree Aerodrome (“the Site”). The development will provide a reliable source of clean renewable energy which will be supplied to domestic and commercial consumers via the National Grid network.

The Proposed Development would supply up to 49.9MW to the National Grid, providing the equivalent annual electrical needs of approximately 15,600 family homes in Hertsmere. The anticipated CO₂ displacement is around 25,400 tonnes per annum, which represents an emission saving equivalent of a reduction in c. 8,100 cars on the road every year. It is also estimated the solar farm will increase the total amount of renewable electricity generated in Hertsmere from 5.4% to 20%, bringing Hertsmere closer to the national average of 33% electricity generated from renewable sources.

The battery storage facility would be utilised to reinforce the power generation of the solar farm. Storing energy at times of low demand and releasing to the grid in periods of higher demand or when solar irradiance is lower, as well as providing balancing services to maintain National Grid stability.

The Application seeks full planning permission for the following Description of Development (the Proposed Development):

“Installation of renewable led energy generating station comprising ground-mounted photovoltaic solar arrays and battery-based electricity storage containers together with substation, inverter/transformer stations, site accesses, internal access tracks, security measures, access gates, other ancillary infrastructure and landscaping and biodiversity enhancements”

This DAS has been prepared in accordance with the regulations set out in Part 3, Article 9 of the Town and Country Planning (Development Management Procedure) (England) (Amendments) Order 2015, which sets out the requirements regarding the contents of a Design and Access Statement.

The DAS explains the thought process behind the design and indicates how, through good design, the Proposed Development can be delivered in a sustainable manner ensuring social, economic and environmental considerations and objectives are fully met in delivering the benefits of renewable energy to meet the urgent national objectives of climate change and energy security and local benefits of farm diversification and biodiversity enhancement.

Hilfield Solar Farm and Battery Storage – R004: Design & Access Statement

Whilst the DAS is set out to be read as a standalone document, it should be read in the context of the entire submission documentation in order to fully understand the Proposed Development, its potential impacts and planning merits. The submission documentation is explained in the Planning Statement (Document Ref: R003).

2 Site Location

The Site has been subdivided into two main parcels and the fields within the Site are referred to as Fields 1 to 20 (Field 6 has been removed from the scheme) as shown on Figure 1 below.

- The western parcel (grid reference: TQ151965 (centre of parcel)) and comprises Field 1 to 5.
- The eastern parcel (grid reference: TQ165975 (centre of parcel)) and comprises Field 7 to 20.

The red line indicates the likely extent of the Proposed Development area which is contiguous with the land under the control of the Applicant. Overall, the red line application site area comprising the grid connection cable route between the two land parcels and twenty adjoining arable fields as shown on Figure 1 below totals an area of approximately 130 hectares. Excluding the grid connection cable route, the Site totals an area of approximately 128 hectares.

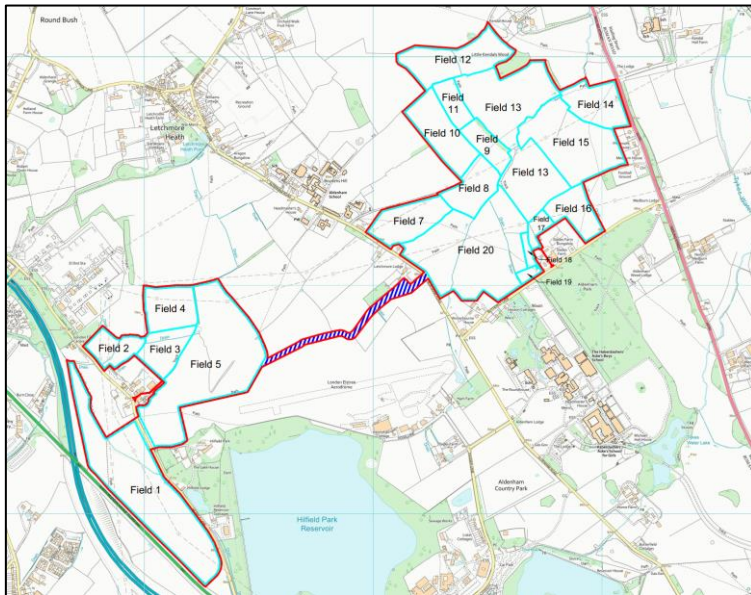

Figure 1: Existing Site Location Plan (see Document Ref: R002 for scale drawing)

The Site is located approximately 3km east of Watford and approximately 2km west of Borehamwood and sits within agricultural landscape, surrounded by energy and transport infrastructure, including the adjacent Elstree Aerodrome and major transport corridors of the M1 and A41. The Hilfield Reservoir lies approximately 100m east of Field 1 (western parcel) and Aldenham Reservoir lies approximately 1km to the south of Field 20 (eastern parcel). Planning permission was granted in August 2019 for the construction of a new equestrian centre (Application Ref: 18/2410/FUL), which is located approximately 400m south of the Site on the western side of the M1 and A41. The Midland Main Line railway is located to the east, approximately 660m from the proposed development at its closest point.

The Site is located wholly within the London Metropolitan Green Belt. The Hertsmere Borough Council Local Plan Core Strategy (2013) identifies that 80% of the borough falls within the Green Belt, with the four main settlements of Borehamwood, Bushey, Potters Bar and Radlett constituting the only urbanised areas in the borough.

The Site is located in a semi-suburban setting, with localised intrusion of man-made features areas, including the Elstree Aerodrome, adjacent to the southern boundary of the western parcel; Aldenham Road, which separates the two parcels; Hilfield Lane, which intersects the western parcel; the M1, which lies approximately 50m west of the western parcel (Field 1); and the A41 (North Western Avenue), which lies adjacent to the southwestern boundary of Field 1; Butterfly Lane and Watling Street, which lie adjacent to the southern and eastern boundary of the eastern parcel (Fields 7 and 20), respectively; properties and schools along Aldenham Road; overhead power lines, which cross over the Site; and the Elstree National Grid Substation which is located within approximately 100m to the northwest of the western parcel (Fields 2 & 4).

The settlements within the wider context of the Site include Letchmore Heath, Round Bush and Radlett to the north; Bushey to the southwest, and Borehamwood to the east.

3 The Site

3.1 Description

The Site is semi-rural in character with some localised intrusion of man-made features. There are no statutory landscape, heritage or ecological designations within the Site.

The Site is currently accessed via Hilfield Road and Butterfly Lane. The Site wholly comprises Subgrade 3b agricultural land, as identified by the Agricultural Land Classification (ALC), which is not considered Best and Most Versatile (BMV) agricultural land.

The Site has been subject to ‘historical landfilling activity’ which is recorded in the southwestern and western areas of the eastern Site parcel (Fields 17, 18, 19 and 20). It is likely that landfilling activity likely took place pre-1974.

The Site is predominantly located in in the Parish Council area of Aldenham, the western parcel does not fall within a parish but the whole Site is within the administrative area of Hertsmere Borough Council.

The field network within the Site is characterised by hedgerows, hedgerow trees and woodland. The Site is gently undulating ranging between approximately 100 – 80m above ordnance datum (AOD). The western parcel rises to its highest elevation in the western area of the parcel (Filed 5), at approximately 100m AOD and slopes in a general northwesterly direction to approximately 80m AOD in Field 2. The eastern parcel rises to its highest elevation in the southern area in Fields 18 and 19, at approximately 90m AOD and slopes in general northeasterly direction to approximately 80m AOD in Fields 13, 14 and 15.

Hilfield Brook flows partly along the boundary of, and through, Field 1, in a northwesterly direction, and a series of drains route into Fields, 2, 3 and 5. A series of drains also flow through the eastern parcel, from a watercourse which routes though the parcel in a northeasterly direction, which forms part of the Tykes Water and Borehamwood Brook, approximately 700m northeast of the eastern parcel. There are approximately six ponds within the Site and a further two immediately adjacent to the site boundary.

In terms of Public Rights of Way (PRoW), restricted byways Bushey 36 and 38 route through Fields 1 and 5 on a general east-west alignment, from the A41 to the Elstree Aerodrome site, continuing as public bridleways Bushey 53 and Aldenham 78. A restricted byway, Bushey 46, routes from public bridleway Bushey 53 in a northerly direction and continues north as Footpath Aldenham 14, both of which form the eastern boundary of Field 5. Footpath Aldenham 30 routes from Footpath Aldenham 14 on northeast-southwest alignment, forming the eastern boundaries of Fields 3 and 4. Footpath Aldenham 30 eventually joins restricted byway Bishey 38 in the southwestern area of Field 5. Footpath Aldenham 40 routes through Fields 6, 7, 8, 9,

13, 15 and 14 (eastern parcel) between Watling Street and Aldenham Road on a general east-west alignment. From Footpath Aldenham 40, Footpath Aldenham 42 routes on a on a northwest-southeast direction toward Butterfly Lane through Fields 7, 20, 18 and 19. Footpath Aldenham 44 routes toward Butterfly Lane northeast-southwest alignment through Field 14, 15 and 16. Footpath Aldenham 43 routes through Field 20, parallel to the south of Footpath Aldenham 40, from Aldenham Road to the west, eventually adjoining Footpath Aldenham 42 to the east. Footpath Aldenham 32 routes along the eastern boundaries of Fields 9 and 11 and continues along the northern boundaries of Fields 11 and 10. v Aldenham 31 routes along part of the northern boundary of Field 12 in the northernmost extent of the Site, and routes in a general northeast-southwest direction between Watling Street to the east and Footpath Aldenham 17 to the north.

4 The Proposed Development

The planning application seeks permission for the construction and operation of a grid-connected solar photovoltaic farm with battery storage, other ancillary infrastructure and landscaping and biodiversity enhancements.



Figure 2: Proposed Site Plan (see Document Reference: R002 for scale drawing)

A summary of the main elements of the Proposed Development is set out below and explained in more detail below:

- Bifacial solar photovoltaic (PV) panels, ground mounted onto a Fixed Tilt system, using a south-facing system at a tilt of 15-30 degrees mounted on a sub structure;
- 16 inverter/transformer stations distributed evenly across the solar farm;
- String combiner boxes to combine multiple strings of PV panels;
- Approximately 20 battery storage containers;
- Compacted crushed stone internal tracks, rolled in layers to allow vehicular access to the substation and between fields;
- 2.2m high security deer type fencing and gates to enclose the parameters of the Site and allow sheep to graze securely;
- Security and monitoring CCTV/infra-red cameras mounted on fence posts along the perimeter of the Site;
- Pole mounted weather stations and monitoring containerised building;
- Underground and cable tray cabling to connect the panels, inverters and battery storage to the proposed on-site substation;
- A security-fenced enclosed substation compound;
- Underground cable connecting the on-site sub-station to Elstree National Grid Substation to the west of the Site;
- Site access; and
- Landscaping planting, biodiversity enhancements.

4.1 Nature of Solar Farms

The purpose of solar farms is to generate energy from daylight using the passive photovoltaic process and then to feed the clean electricity into the national grid for transmission and distribution. The co-located battery units will store electricity at times when grid-demand is lower and export at times of high demand or when solar irradiation is lower in order to provide a secure and consistent supply from the solar farm to the grid network.

4.2 Components of a Solar Farm

The solar farm as proposed has the following key components.

4.2.1 Solar Arrays

Solar panels would be laid out in rows with gaps of approximately 3-4.5m between each row depending on the topography of each field. Panels are mounted on a fixed tilt system mounted on a structure made of galvanized steel or aluminium. The metal framework that supports the solar panels would be fixed into the ground by posts centred c. 6m apart. The posts would be pile-driven (like a fence post) into the turf to a depth of around 2-2.5m. This approach means no concrete is needed to secure the system and the posts can be easily removed with no permanent impact at the end of the solar farm's temporary consent.

The arrays would utilise high-efficiency bifacial panels and at a fixed tilt of between 15-30 degrees and orientated broadly facing south between 165-200 degrees.

Bifacial panels absorb light on both sides of the panel – both directly on the top-side, and reflected light is also absorbed on the rear-side.

The panel technology also utilises high efficiency monocrystalline cells meaning fewer panels are required to be installed on the site to achieve the target capacity. The combination of high-efficiency bifacial panels and optimised configuration increases the production of electricity from the Proposed Development by 4% compared to monofacial systems.

The use of best available and state of the art technology on the Site aims to maximise the use and productivity of the land for the generation of renewable energy.

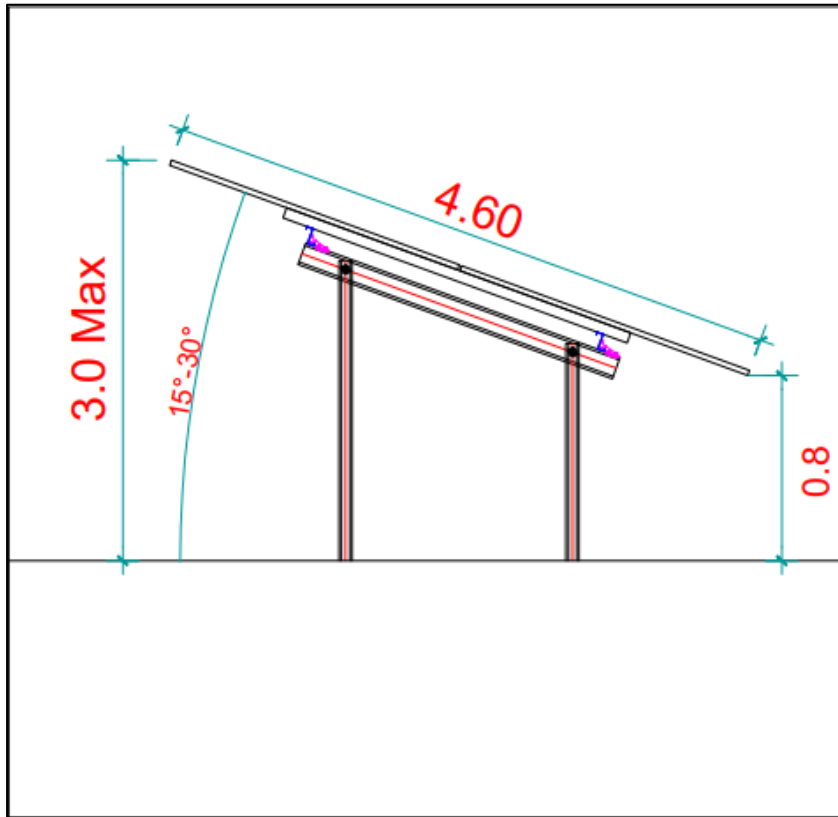

Figure 3: Bifacial Solar PV Panel Elevation (see Document Reference: R002 for scale drawing)

At their lower edge panels would be approximately 0.8m from the ground and up to approximately 3m at their higher edge depending on the position of the static array within the topography of the site.

- The positioning of the arrays responds to existing physical features such as ditches, ponds, trees and hedgerows with panels set back appropriate buffer distances as informed by technical guidance.

- The Proposed Development conforms to Environment Agency Regulations and maintains a minimum stand-off from watercourses within or adjoining the Site.
- Advice from National Grid has been followed to ensure appropriate stand-off from pylons where required and clearance distance distances under overhead cables during construction, as well as allowing for the maintenance of their access to their assets.
- Guidance has been followed on appropriate stand-off distances from below ground utility services including electricity, water and gas mains that cross the Site.

4.2.2 Inverters and Transformers

Sixteen inverter/transformer stations will be located throughout the solar farm.

The inverters are within metal containers that will be finished in green and positioned on a hardcore base. Each unit measures c. 12m x 2.4m x 2.9m (LxWxH) i.e. relatively low in height. The containerised solution makes their removal at end of the operational life easier.

Inverters convert direct current (DC) generated by the PV panels into alternating current (AC). Transformers then convert low voltage output from the inverters to high voltage suitable for feeding into the network.

The transformers are located next to the inverters and inside the containerised solution alongside the switchgear, which have a less visual impact as all the electrical units are contained internally.

4.2.3 Battery Storage Units

The Battery Storage units would be housed within approximately 20 shipping containers or similar, with each unit measuring approximately 12m x 2.4m x 2.9m (LxWxH) within a defined a battery storage area in the western site (see Document Ref: R002 for site layout drawing), comprising hardcore surface. Each container will be finished in green and not stacked.

It will be positioned in the western parcel next to the site substation near the Elstree National Grid Substation boundary away from noise sensitive receptors.

4.2.4 Substation

There would be one substation and auxiliary switchgear area on site measuring approximately 12.5m x 5.5m x 4.2m (LxWxH) sited on hard core or concrete slab.

The on-site substation would combine electricity from the transformers and batteries distributed across the site before transferring it to the Elstree National Grid Substation immediately to the north of the western parcel (see Document Ref: R002 for site layout drawing) via underground electrical cables.

4.2.5 Cabling

Underground cabling will be required to connect the generating substation to the Point of Connection at Elstree National Grid Substation. The boundary of the western parcel is shared with land within National Grid ownership. The Applicant has signed a Bilateral Connection Agreement with National Grid allowing for export and import of the full capacity of the project.

The cables linking all the PV arrays to the inverter/ transformer stations including the connection between the two field parcels north of the aerodrome will be via underground or cable trays above ground and underground from the inverter/transformer stations to the on-site substation.

4.2.6 Site Security Measures

The generating station would need to be secure to prevent theft and criminal damage during both the construction and operational phases of the development and to ensure health and safety.

It is proposed that deer fencing c. 2.2m high would be installed around the perimeter of the Site, comprising wooden fence poles and galvanised fences with gates. The fencing would enclose the solar panels within each field and allow sheep to graze securely. The fence will be erected with a minimum 5m stand-off either side of all PRow to maintain public accessibility by excluding it from the operational site. Gates will be installed to allow for movement between each area of the development and for operators to access their equipment.

The perimeter of the Site would be protected by a system of CCTV and/or infra-red cameras, which would provide full 24-hour surveillance around the internal perimeter. An intelligent sensor management system would manage the cameras. Cameras would be inward facing on poles of up to approximately 2.4m high, spaced at approximately 50-70m intervals along the fence. (see Document Reference: R002 for scale elevation drawing)

There would be no permanent security lighting within the Site at night-time.

4.2.7 Lighting

No permanent operational lighting is proposed within the Site.

Manually operated lights may be attached to the substations and transformer and/or inverter cabinets in the event of an emergency maintenance visit being required in the hours of darkness.

4.3 Materials & Appearance

Details of the materials and appearance of the proposed solar arrays and associated infrastructure are provided on the application drawings contained in Document Ref: R002.

5 Construction

5.1 Construction

It is anticipated that the construction phase will last for approximately 40 weeks.

Two points of construction access are proposed via Hilfield Lane to the west for Fields 1 to 5 and the substation/battery energy storage compound (through Hilfield Farm) and from Butterfly Lane to the east (through Slades Farm) for fields 7 to 20.

Construction activities will be carried out Monday to Friday 08:00-18:00 and between 08:00 and 13:30 on Saturdays. No construction activities or deliveries will occur on Sunday or Public Holidays. Where possible, construction deliveries will be coordinated to avoid construction vehicle movements during the traditional peak hours. As there are several schools in the area, deliveries will be coordinated during term time and weekdays to avoid drop off and pick up times, between 07:30-09:00 and 15:00-18:00. As such, all deliveries during these periods will be made between 09:00-15:00.

It is anticipated that there will be 1,084 deliveries by HGV (comprising 16.5m articulated and 10m rigid vehicles) including construction traffic associated with constructing internal access roads, general movements and other site equipment during the construction period. It is expected that there will be an average of around five HGVs per day accessing the Site over the construction period (10 two-way movements).

Approximately 120 construction workers are anticipated to be required on-site during peak construction. The location where staff will travel from is unknown at this stage as it will depend on the appointed contractor. However, it is envisaged that the majority of non-local workforce will stay at local accommodation and be transported to the Site by minibuses to minimise the impact on the strategic and local highway network. Notwithstanding this, appropriate car parking provision for construction workers and visitors will be provided within the contractor compounds.

No parking by contractors, visitors or delivery vehicles will be permitted on the local highway network or the Site access road at any time during the construction phase, and visitors will be advised of the parking arrangements in advance of travelling to the Site. The Site Manager will monitor that parking is taking place in the designated area on a regular basis.

No diversion of pedestrian routes, parking suspensions or closure of lanes or closure/diversion of PRow are required. An underground cable will be installed to connect each Parcel of Land. This will need to cross Aldenham Road and Hilfield Road. Prior to these works being undertaken, all appropriate licences will be obtained, and traffic management agreed with the relevant authority.

Two secure temporary construction compounds (one next to the substation/battery site in the western section accessed from a temporary construction access from Hilfield Lane to service Fields 1 to 5 and the second on the eastern site where the access track enters the Site from Slades Farm for Fields 7 to 20) will be used to store materials and ancillary welfare facilities during the construction period. This does not form part of the Proposed Development. In the event of the Proposed Development being granted planning permission, the compounds will be provided under associated Permitted Development rights.

The temporary compound(s) will likely (but not limited to) include:

- Temporary portable buildings to be used for offices, welfare and toilet facilities;
- Containerised storage areas;
- Parking for construction vehicles and workers vehicles;
- Temporary hardstanding; and
- Wheel washing facilities.

In addition, the Proposed Development will include internal access roads (3.5-6.0m wide) throughout the Site allowing for the movement of construction and maintenance vehicles.

If ground conditions dictate, wheel washing facilities and road sweepers will be provided to ensure no mud or loose material is transferred onto the local highway network. In such circumstances all construction vehicles will have to exit through the wheel wash area.

Further detail is contained in the accompanying Construction Traffic Management Plan (CTMP) (Document Ref: R005).

5.2 Maintenance

Solar farms require little maintenance, with activity limited to occasional visits to clean (using only distilled water), check and conduct preventative maintenance on the installation, with personnel using small vehicles (4x4 or transit van type). Use of larger vehicles may be required if necessary to replace any defective components, should any equipment fail during the lifetime of the farm.

There will be two points of Operational Access via Hilfield Lane to the west (through Hilfield Farm) and Butterfly lane to the east (through Slades Farm).

The ground around and beneath the arrays will be seeded with a grass mix which will be managed by occasional mowing and/or grazing by sheep

Pesticide treatments will not be used as part of the grounds-keeping regime.

Further detail is contained in the accompanying Landscape and Ecological Management Plan (LEMP) (Document Ref: R009).

5.3 Operational Lifespan and Decommissioning

The Proposed Development would export renewable energy directly to the National Grid for a period of 35 years.

The battery storage element is also expected to operate for a minimum of 35 years. The solar and battery elements could either be delivered independently of each other or at the same time. They could therefore be constructed and become operational either independently or at the same time.

At the end of the useful life of the Project, the Applicant may decommission, replace or refit the modules, or if required to by condition following a period of 12 months of non-continuous generation. An appropriate method statement based on the preferred option for decommissioning will be prepared and submitted to the Council for their consideration and agreement.

The proposed scheme including the penetrative ground fixings are fully reversible and all structures can be removed from the site and the land reinstated to agricultural use. Many of the component parts, including the aluminium framework and silicon in the module panels, can be recycled for other uses. Should the modules be decommissioned, this will be undertaken within six months of notice given to the Council and is anticipated to follow the construction stages in reverse. Reinstatement will occur at each stage of the decommissioning and all waste removed from site to a suitably licensed facility.

Vehicle movements are anticipated to be the same as per the construction period.

5.4 Climate Change

The strategy and action plan for how Hertsmere Borough Council will achieve net zero carbon emissions by 2050 were approved by Full Council on 14 October 2020. Hertsmere is one of 205 local authorities, alongside Hertfordshire County Council, St Albans City and District Council, Watford Borough Council and Dacorum Borough Council, who have declared a climate emergency and committed to taking urgent action to reduce their carbon emissions. Hertsmere declared a climate emergency in September 2019 and is committed to achieving carbon neutrality as soon as possible and no later than 2050.

The Proposed Development will generate electricity from a renewable resource and thus responds directly to the threat of climate change. The anticipated CO₂ displacement is around 25,400 tonnes per annum, which represents an emission saving equivalent of a reduction in c. 8,100 cars on the road every year. It is also estimated the solar farm will increase the total amount of renewable electricity generated in Hertsmere from 5.4% to 20%, bringing Hertsmere closer to the national average of 33% electricity generated from renewable sources

The Flood Risk Assessment (FRA) (see Document Ref: R010) takes account of the effects of climate change in calculating potential flood levels, which determine the level at which components of the Proposed Development will be installed.

6 Site Selection

6.1 Environmental Context

A request for a Screening Opinion was submitted to Hertsmere Council on 4 August 2020 (ref. 2017-R001). A response was received on 10 September 2020 (20/1183/EI1) confirming an Environmental Statement (ES) would be required under the Town & Country Planning (Environmental Impact Assessment) Regulations 2017 and that the only topic that would be required to be addressed within the Environmental Statement (see Document Ref: R007 and R008) is Aviation Safety impacts.

A Non-Technical Summary is submitted with the ES (see Document Ref: R006);

In addition, the following environmental studies and supporting documents accompany the planning application and are cross referred to in the Planning Statement (see Document Ref: R003);

Hilfield Solar Farm and Battery Storage – R004: Design & Access Statement

Document	Author	Reference
Covering Letter, Application Form and Certificates	Aardvark EM Limited	R001
Planning Application Drawing Pack	Aardvark EM Limited and Blueleaf	R002
Planning Statement including Green Belt Assessment	Aardvark EM Limited	R003
Design and Access Statement	Aardvark EM Limited	R004
Construction Traffic Management Plan	Transport Planning Associates	R005
Non-Technical Summary of the Environmental Statement	Aardvark EM Limited and Pager Power Limited	R006
Environmental Statement Main Text	Aardvark EM Limited and Pager Power Limited	R007
Environmental Statement Technical Appendices	Aardvark EM Limited and Pager Power Limited	R008
Landscape and Ecological Management Plan	LDA Design and BSG Ecology	R009
Flood Risk Assessment and Drainage Strategy	RMA Environmental	R010
Noise Impact Assessment	Inacoustic	R011
Glint and Glare Assessment	Pager Power Limited	R012
Ecological Impact Assessment Report (including Biodiversity Net Gain Statement)	BSG Ecology	R013

Statement of Community Involvement	Alpaca Communications	R014
Agricultural Land Classification Report	Askew Land and Soil Limited	R015
Ground Investigation Assessment	R M Cameron Environmental Services Ltd	R016
Heritage Desk Based Assessment	Headland Archaeology	R017
Landscape and Visual Impact Assessment	LDA Design	R018

6.1 Economic Context

The project is one of several solar farm battery storage proposals being brought forward by the Applicant across England and Wales. The proposed scheme will supply up to 49.9MW for export to the National Grid at Elstree National Grid Substation.

Due to the relatively low income from farming, many farmers have had to diversify to secure an economically sustainable profit. Farm diversification is broadly defined as *'the entrepreneurial use of farm resources for a non-agricultural purpose for commercial gain'*. Hence, diversification reflects the reduced dependence of farmers on agriculture as a source of income. Diversification also implies entrepreneurial activity on behalf of the farmer.

Renewable energy is an important form of diversification and the additional income generated by the solar array project will help to subsidise and secure the landowners farming business whilst allowing them to continue farming on the remaining landholding. Farming businesses play a vital role in the rural economy, particularly supporting the agricultural supply chain to include feed merchants, machinery sales, maintenance and repair businesses, local builders, delivery drivers and professional services, to name but a few. The solar array project would help to support the local agricultural supply chain via the income to the farming business, especially following the proposed subsidy reforms post Brexit.

It is important that solar farm applications such as this one are progressed as urgently needed infrastructure necessary to meet the UK's legally binding commitment to a net zero target. To restrict or limit development for such projects through the planning system, especially those that have significant policy support could be damaging in an economic and social context in the longer term as well as that of climate change given the pressing need to move away from fossil fuels.

6.2 Social Context

The Proposed Development will have no direct adverse social impacts on individual members of the local community or those in the wider area by virtue of noise pollution or other potentially adverse effects on the environment. However, the Proposed Development, which is concerned with the generation of energy from renewable resources, responds directly to the threat of climate change and will thus indirectly provide social, economic and environmental benefits to the wider population.

Farm diversification is key to the long-term survival of farms such as the one on which the Proposed Development is sited. The revenue from the proposed array will provide a diversified income for the farm. The landscape character we enjoy today has been developed by generations of farmers managing the land. This proposed project will help protect the viability of the farm enabling the farming business to continue their stewardship of the land.

The NFU (National Farmers' Union) announced plans to make British agriculture carbon neutral within two decades and with farming responsible for around a tenth of UK greenhouse gas emissions, this will be a vital step on the road to reaching net zero. Alongside switching to more environmentally friendly working practices and enhancing land and buildings in ways that will help lower emissions, diversifying into renewable technologies presents a natural next step as well as providing an important diversified income resource for farming.

The Proposed Development would supply up to 49.9MW to the National Grid, providing the equivalent annual electrical needs of approximately 15,600 family homes in Hertsmere. The anticipated CO₂ displacement is around 25,400 tonnes per annum, which represents an emission saving equivalent of a reduction in c. 8,100 cars on the road every year. It is also estimated the solar farm will increase the total amount of renewable electricity generated in Hertsmere from 5.4% to 20%, bringing Hertsmere closer to the national average of 33% electricity generated from renewable sources.

6.3 Planning Policy

The Solar Trade Association (STA) sets out “10 Commitments” of good practice in solar farm development. In terms of design and access issues, this includes such matters as ensuring consideration is given to minimising disruption during construction and operation such as a suitable plan being in place for construction traffic and where land is damaged by trenching or machinery, ensuring it is reinstated to its current condition at the end of construction. A full description of how the Proposed Development meets these commitments is set out in the submitted Planning Statement (see Document Ref: R003).

The local planning policy framework also encourages the generation of electricity from renewable sources. The detail on the prevailing planning policies pertaining to the Proposed Development is set out in the submitted Planning Statement.

6.4 Evaluation

The environmental studies and other analysis have established that the Site is suitable for a solar farm and battery storage and informed the design and access issues of the proposed scheme such that it does not give rise to unacceptable impacts.

The renewable led energy scheme is compliant with planning policy and the Site has been carefully selected such that the nature of the local topography coupled with the schemes low profile physical height of the solar panels results in only limited views of the Site being possible.

It is considered that the scheme layout and design will not have an unacceptable adverse effect on the local environment or the visual or amenity value of the local environment nor the wider area.

7 Use

The Application is for the installation of renewable energy generating station comprising ground-mounted photovoltaic solar arrays and battery-based electricity storage containers together with substation, inverter/transformer stations, site accesses, internal access tracks, security measures, access gates and other ancillary infrastructure. The nature of such a solar farm, the site selection process and the suitability of the Site for this use are described earlier in this document.

The use of land in the countryside to produce energy is consistent with tradition and practice going back to when woodland was planted and managed to generate wood for fuel. In the present day, fuel is derived from arable crops such as maize and rapeseed, and other crops are grown as biomass fuel.

The UK imports both food and fuel and security of supply is a factor in relation to both. The use of farmland such as this Site for energy production will contribute to the UK's energy security and to a reduction in its reliance on fossil fuels.

The Site is currently used for arable cultivation. Once operational, the Site will no longer be capable of being utilised for this type of harvesting agriculture but may be used for sheep grazing and as such can retain its agricultural use albeit less intensive than the current arable cropping regime, thereby allowing the site to recover and soil condition improve.

8 Layout

The solar modules will be mounted on the structural frame. The arrays are arranged in an east-west aligned linear fashion with suitable spacing across the Site, meaning that when viewed from above, the gaps between rows are wider than the area of ground covered by the panels.

The arrays will be laid out east-west in order for the modules to face between 165 and 200 degrees south at an optimised angle between 15 and 30 degrees for generation. A fence will surround the fields, with gates to allow access (e.g. for security or maintenance) at intermittent locations. There will be an infrared CCTV system installed around the perimeter of the Site adjacent to the fence, on poles facing into the Site. The inverters/transformers will be erected and distributed across the Site to combine the output for the PV arrays.

A substation is proposed adjacent to the western boundary of the Site close to Elstree National Grid Substation. The substation will utilise the principal access used for the Site during construction and for subsequent maintenance access.

The layout of the scheme has evolved throughout the over the course of the design process as the project team have continuously refined the scheme's design to encompass the Councils and other stakeholders' feedback. Local community feedback is set out in the Statement of Community Involvement (Document Ref: R013).

Buffer zones (informed by relevant technical guidance and advice) have been designed into the proposed layout including:

- No solar panels within 10m of a PRoW;
- No solar panels within 9m of a drainage ditch or watercourse;
- No development within 9m of the top of a boundary drainage ditch or watercourse.

The overall extent of ground disturbance on Site would be minimal being approximately 4% of the overall site area as a result of the underground cabling, internal access roads, inverter/transformer stations, panel frames and proposed on-site substation and battery storage facility.

The initial layout design 'Concept Design' was primarily influenced by land availability, solar irradiation levels and physical site constraints, these were then developed through the EIA Screening process, after the baseline studies/preliminary impact assessments and during the pre-application engagement with the local community to reach the submitted Site Layout plan. This iteration process is shown on the figures below.

Hilfield Solar Farm and Battery Storage – R004: Design & Access Statement

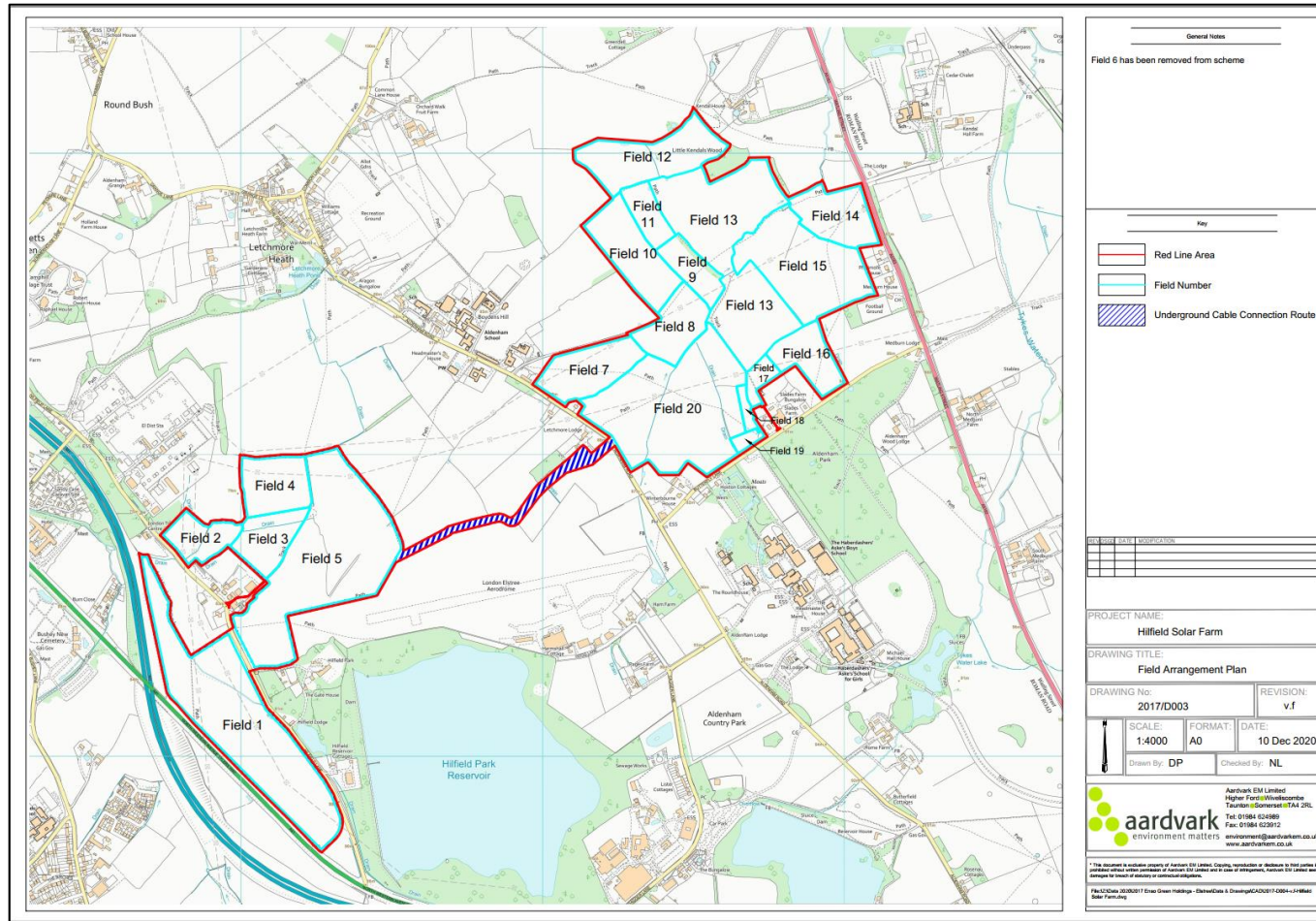

- Available fields identified and numbered for ease of reference
- Identified physical constraints – river, drainage ditches, residential receptors
- PRoW identified
- Access option identified
- Woodland areas identified
- Field boundaries retained

Figure 4: Site Boundary Plan



- Panel configuration identified to optimise the energy density of the site
- Internal access tracks layout
- Buffer zone to PRow
- Buffer zones from ditches, hedgerows
- Buffer zone from flood risk areas
- Area identified for substation and battery storage
- More detailed review of access arrangements from Hilfield Lane and Butterfly Lane

Figure 5: Master Plan submitted with EIA Screening Request

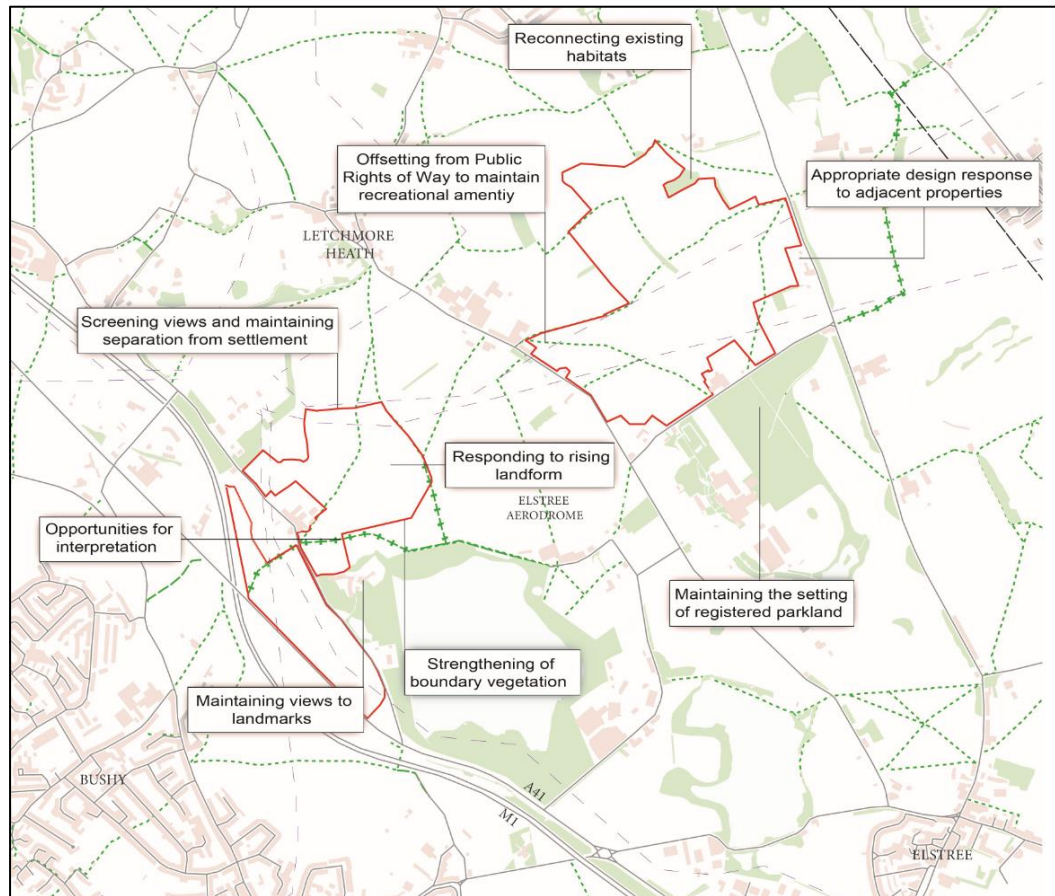

Figure 6: Design Journey plan submitted with EIA Screening Request

- Suitable offset to allow for new planting and enhancement of the existing field and boundary vegetation;
- Minimising potential impact on landscape fabric by avoiding and buffering existing landscape features such as woodland, trees, hedgerows and ditches;
- Enhancement of existing hedgerows;
- Creation of buffers around PRoW through the Site to maintain their recreational amenity;
- Use of a sensitive colour pallet for built structures to aid assimilation into the landscape;
- Creation of additional habitats to strengthen visual screening, enhance landscape character and increase biodiversity/green infrastructure;
- Linking in the Site's potential ecological enhancements with the existing surrounding areas of nature conservation;
- Creating a buffer around woodland and hedgerows; and
- A 9m maintenance buffer along 'main rivers' and a 6m maintenance buffer along all other 'ordinary watercourses'.

Hilfield Solar Farm and Battery Storage – R004: Design & Access Statement



Figure 7: Local Community Consultation Plan

- Formed part of local community consultation
- Highlights areas where panels could be pulled back
- Options for substation and battery facility location
- Options for green corridors
- Options of retained heritage views
- Information board location options
- Potential boundary landscape planting identified and wildflower planting
- Retention of existing vegetation and boundaries
- Offsetting of solar panels from existing boundaries, water courses and ditches
- Site access options from Hilfield Lane and Butterfly Lane for traffic identified
- Key PRoW identified

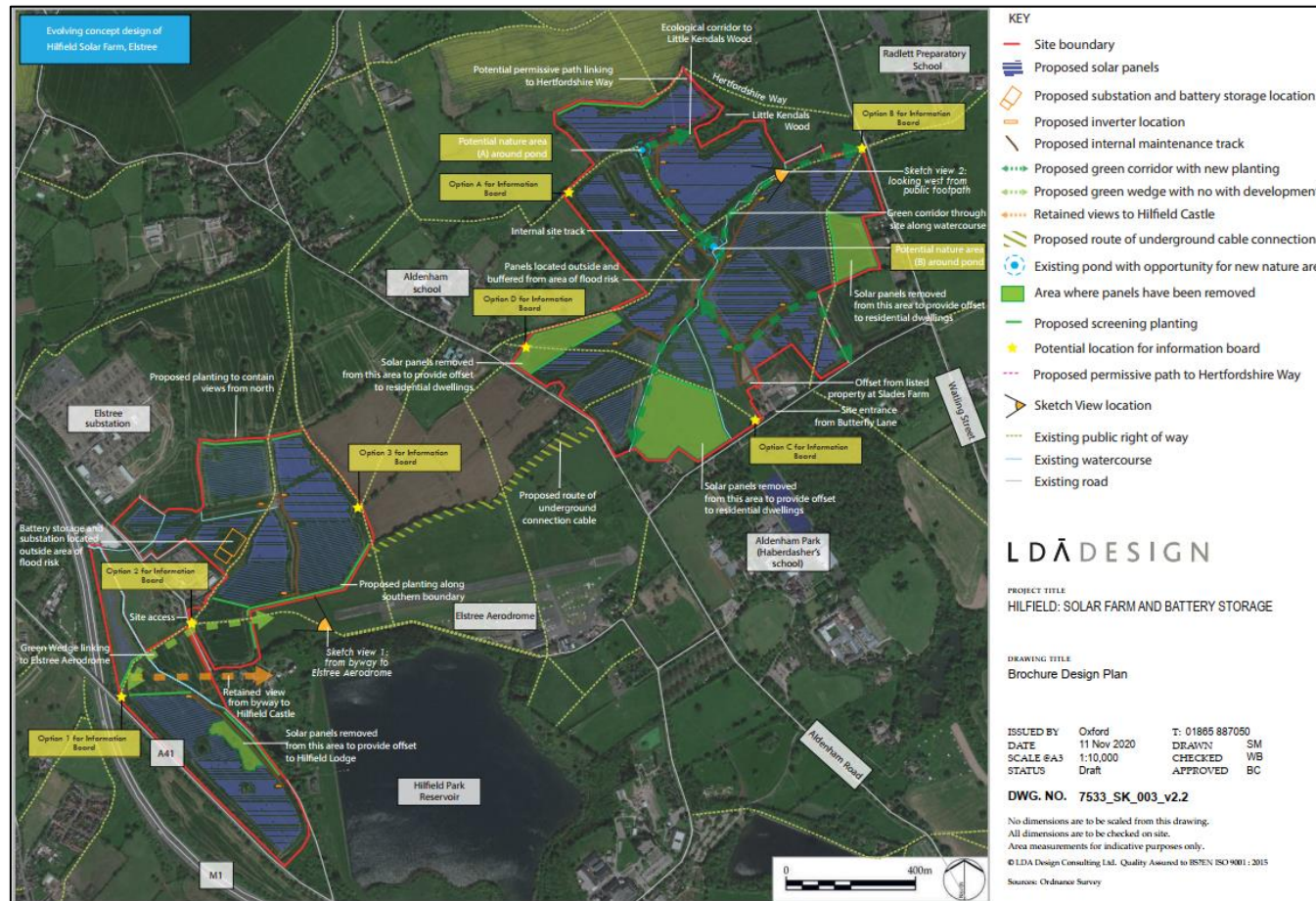

- Key design principles and considerations plan collating consultation feedback in design terms from desk-based assessments and field studies
- Identifies underground connection cable route
- Pulls together buffer offsets and mitigation offsets from panel layout
- Removes panels from key pull back areas from residential properties
- Removes panels from 'green wedge' and retained views of Hilfield Castle
- Identifies sensitive design areas such as higher ground and possible nature areas
- Identified green corridor aligned with the watercourse through the eastern parcel

Figure 8: Design Inputs Plan from site assessments

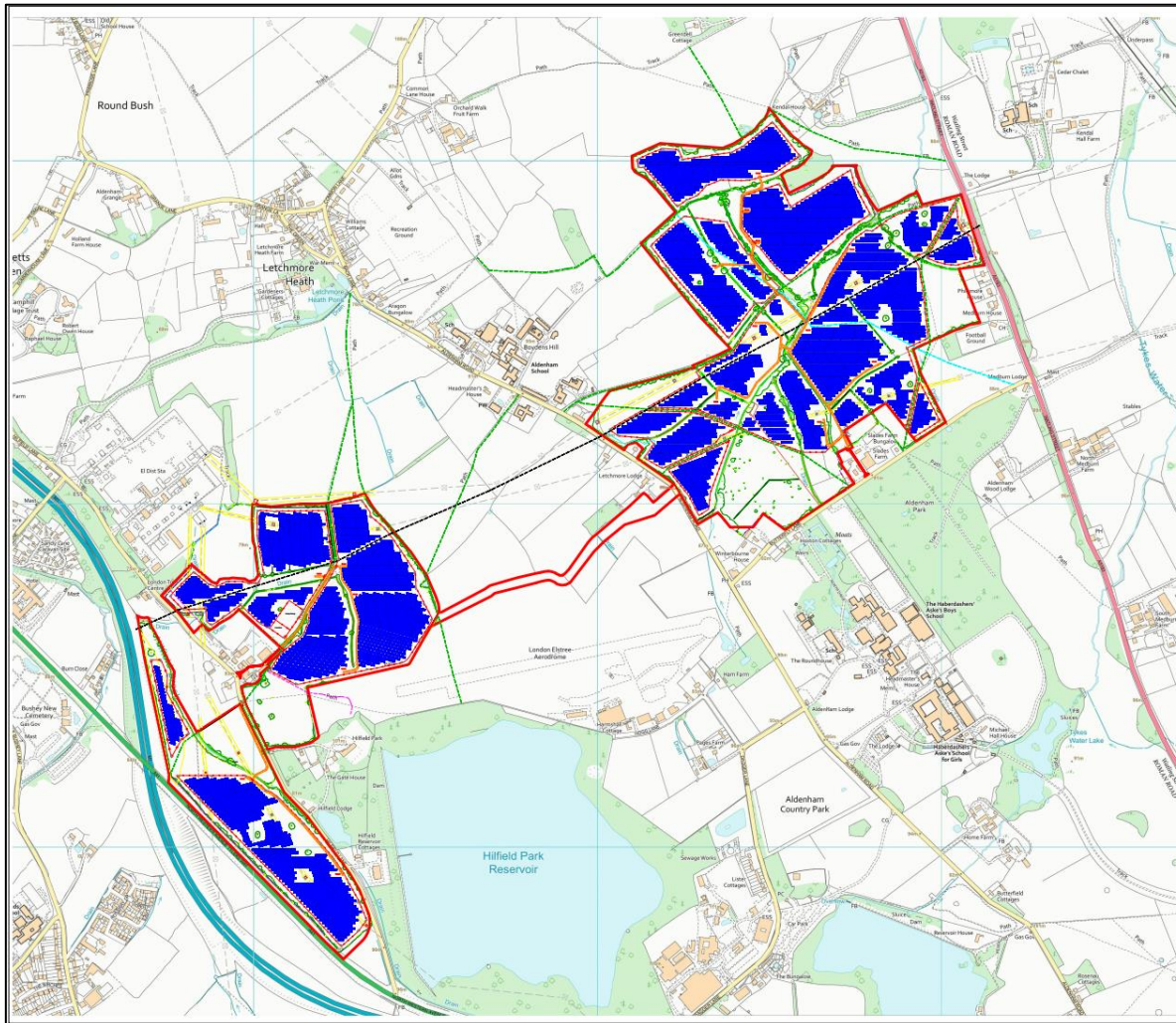

- Informed by LVIA and LEMP
- Reorientation and change of pitch of solar panels to avoid glint and glare effects
- Inclusion of underground grid cable connection between the two parcels
- Addition of permissive paths
- Pull back of panels to allow landscape and biodiversity enhancements

Figure 11: Application Layout (see Document Reference: R002 for scale drawing)

9 Amount & Scale

The red-line application area of the overall Site including the grid connection route is approximately 130 hectares.

Solar panels would be laid out in rows with gaps of approximately 3-4.5m between each row depending on the topography of particular fields. Panels are mounted on a frame made of galvanized steel or aluminium.

The metal framework that supports the solar panels would be fixed into the ground by posts centred c. 6m apart. The posts would be pile-driven (like a fence post) into the turf to a depth of around 2-2.5m. This approach means no concrete is needed to secure the system and the posts can be easily removed with no permanent impact at the end of the solar farm's temporary consent.

At their lower edge panels would be approximately 0.8m from the ground and up to approximately 3m at their higher edge depending on the position of the panel within the site topography.

The height of other infrastructure associated with the development, i.e. inverters and substations, will be a maximum of approximately 3m. The pole mounted CCTV cameras will be approximately 2.4m high.

Although the development requires a large area of land, in terms of physical intrusion the development would only impact a small proportion of the red-line site area due to the limited surface area required to support the solar panels above-ground presence. The overall extent of ground disturbance on-site would be minimal with just 4% of the overall site area excavated as a result of the underground cabling, internal access roads, inverter/transformer stations, panel frames and proposed on-site substation and battery storage facility.

Once the PV system has reached the end of its useful life, the entire system will be removed, and the field will return to agricultural use with no residual impacts therefore the Proposed Development should be considered fully reversible. The soil will have rested and likely to have improved by absence of intensive agricultural farming practices during the operational lifetime of the Site.

10 Appearance

Details of the proposed solar arrays and associated infrastructure are provided on the application drawings submitted with the application (see Document Ref: R002).

Drawing No	Plan Name
HF1.0	Location Plan
HF1.1	Location Plan – Eastern Parcel
HF1.2	Location Plan – Western Parcel
HF2.0	Proposed Site Plan
HF2.1	Proposed Site Plan – Eastern Parcel
HF2.2	Proposed Site Plan – Western Parcel
HF3.0	PV Elevations
HF4.0	Inverter Transformer Stations
HF5.0	Internal Access Road Elevations
HF6.0	Fence and Gate Elevations
HF7.0	Weather Station Detail
HF8.0	Substation Elevations

Hilfield Solar Farm and Battery Storage – R004: Design & Access Statement

HF9.0	Control Room Elevations
HF10.0	Auxiliary Transformer
HF11.0	CCTV Elevations
HF12.0	Battery Container Elevations 40ft
HF13.0	Storage Container Elevations
7533-012	Landscape and Ecological Enhancement Plan (LEEP)
HF14.0	Field Topographical Data East
HF15.0	Field Topographical Data West

11 Landscaping and Biodiversity

Landscape and biodiversity mitigation proposals are incorporated into the scheme design and are detailed in the LVIA (Document Ref: R007), the Ecological Impact Assessment and Biodiversity Net Gain Assessment (see Document Ref: R013); and the LEMP (Document Ref: R009).

The landscape and biodiversity mitigation proposals include measures that aim to avoid, reduce, or remedy significant adverse impacts on the landscape and ecology by ensuring that the scheme has a good fit within the landscape and biodiversity setting. It also includes measures that would reduce the visual prominence of the solar arrays in local views by enhancing the condition of key field boundaries on the perimeter of the Site.

The proposals in the LEMP will secure the scheme's net biodiversity benefit. This is tested and set out in the Biodiversity Net Gain Assessment.

The proposed hedgerow, scrub and tree planting and landscape management would produce landscape features of the specified height and provide effective screening towards the Proposed Development within 15 years (medium-term). The proposed elements would also enhance the local landscape character and provide additional screening towards the Proposed Development).

The LEMP sets out how the Proposed Development would:

- Significantly enhance the overall biodiversity value of the Site, including for protected and notable species and habits and locally designated sites;
- Protect and enhance the existing characteristics and features of value of the Site including the field structure, mature trees, hedgerows and ditches;
- Create a strong structural planting framework and protect, restore and maintain the existing vegetation network, which would also provide enhanced screening of close- and middle-distance views of the Proposed Development.
- Create greater opportunities for protected species' and species of conservation concern;
- Significantly enhance the Green Infrastructure connectivity within the Site and wider landscape, contributing positively to aspirations set out with the Hertsmere Green Infrastructure Plan (2011);
- Facilitate opportunities for engagement with the natural environment and renewable energy;
- Protect and enhance recreational amenity from PRoW;
- Secure the long-term future management of the Site for the duration of the Proposed development.

12 Access

The details of the construction vehicle routes are set out in the CTMP submitted with the application (See Document Ref: R005). The design of the proposed Site access/egress is provided in the Planning Application Drawing Pack (Document Ref: R002).

The Site is located close to the strategic highway network, being east of the M1 Motorway and A41, south of the M25 and west of the A1. The identified routes, as set out below, are considered the most appropriate route to connect the Site to the strategic road network, avoiding all weight restrictions in the local area.

Construction traffic will route to the western parcel from the M1 Motorway via the following route;

- M1 Motorway Junction 5;
- A41 North Western Avenue;
- Sandy Lane; and
- Hilfield Lane.

Construction traffic will route to the eastern parcel from the M1 Motorway via the following route;

- M1 Motorway Junction 5;
- A41 North Western Avenue;
- Dagger Lane;
- Aldenham Road; and
- Butterfly Lane.

The details of the construction vehicle routes have been discussed with officers at HBC and Hertfordshire County Council and are considered, subject to management of delivery times to be the most appropriate for use by construction vehicles and are discussed in more detail within the CTMP.

12.1 Construction Access and routing

The designated route for all construction vehicles associated with the construction period is shown in the CTMP. Visitors, delivery drivers and contractors will be advised of the route in advance of driving to the Site.

The designated routes require all construction vehicles to access the Site from the identified construction access points existing agricultural access junctions on Hilfield Lane and Butterfly Lane.

The proposed construction vehicle routes are direct routes straight from the strategic highway network to the Site

The use of any other roads other than the designated and signposted route shall not be permitted and this shall be enforced through the agreement of the CTMP.

Appropriate mitigation measures will be provided throughout the construction phase in order to manage the arrival and departures of HGVs at the Site.

12.2 General Site and Maintenance Access

Monthly maintenance visits will be scheduled after commissioning of the Site, supported by call outs to attend to remedial issues, as required. Once operational there would typically be two maintenance visit per month comprising a small van or car from the existing farm accesses off Hilfield Lane and Butterfly Lane.